

High-pressure switch for gas, air, flue gases and combustion products

GW...A4 HP
GW...A4/2 HP

DUNGS[®]
Combustion Controls

5.04



Technical description

The GW...A4 HP pressure switch is an adjustable pressure switch as per EN 1854 (GW 6000 A4 as per DIN 3398T3) for burners.

It is suitable for closing, opening or switching over a current circuit when the actual pressure value deviates from the specified pressure setpoint. The specified pressure setpoint (operating point) is set at a setting wheel using a scale.

Application

Pressure monitoring in burner control systems

Suitable for gases of gas families 1,2,3 and other neutral gaseous media, as well as air, flue gases and combustion products.

Approvals

EU type test approval as per EC Gas Appliance Directive:

GW...A4... CE-0085 AO 3220

EU type test approval as per EC Pressure Equipment Directive:

GW...A4... CE0036

Approvals in other important gas-consuming countries.

Functional

Pressure switch for applications involving excess pressure.

GW...A4 HP

The pressure counteracts the force of the setting spring on the micro-switch via the metal bellows. The pressure switch does not require power assistance.

Pressure switch GW...A4 HP

The switching mechanism reacts to overpressure and closes, opens or switches over a current circuit when the specified pressure setpoint is overshoot or undershot.

All gas-carrying parts are made of 1.4541 stainless steel and, therefore, are suitable for:

- applications involving operating pressures greater than 600 mbar
- aggressive media such as sulphuric acid up to a concentration of 1.0 % by vol., humid
- fluids (on request)

Switching function

As pressure rises:

1 NC opens, 2 NO closes.

As pressure falls:

1 NC closes, 2 NO opens.

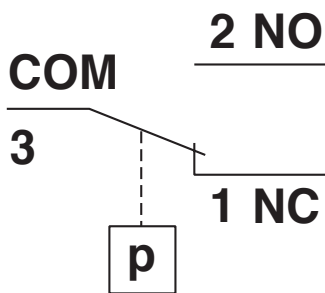

Definition of switching difference Δp

The switching difference Δp is the pressure difference between the upper and lower switching pressures.

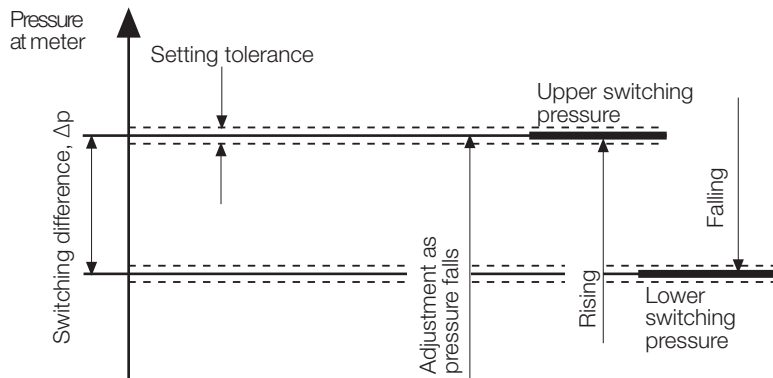

GW...A4, Design: Clear cover

Degree of protection IP 54

- IP 54**
- 5 Protection against ingress of solid particles $\varnothing \geq 1$ mm
Protection against access to hazardous parts with a wire, $\varnothing \geq 1$ mm
Complete contact protection
 - 4 Protection against a water jet.
No hazardous conditions may result.

GW...A4, Design: Metal housing

Degree of protection IP 65

- IP 65**
- 6 Protection against the entry of dust (dust sealed).
Protection against access to hazardous parts with a wire, $\varnothing \geq 1$ mm
Complete contact protection
 - 5 Protection against a water jet from a nozzle directed at the unit (housing) from any directions
No hazardous conditions may result (water jet).

Specifications

Max. operating pressure	GW 500 A4 HP	p_{\max}	= 2 bar (gas) @ setting range 0.1 - 0.5 bar	
		p_{\max}	= 5 bar (gas) @ setting range 0.15 - 0.5 bar	
	GW 2000 A4 HP GW 6000 A4 HP	p_{\max}	= 5 bar (gas) = 8 bar (gas)	
Pressure connection	p+: centrally on underside of housing, G 1/4 internal thread to ISO 228: Gas or air			
Temperature range	Ambient temperature	-15 °C to +70 °C		
	Medium temperature	-15 °C to +70 °C		
	Storage temperature	-30 °C to +80 °C		
Materials	GW...A4 HP			
	Housing lower section	aluminium die casting		
	Switch	polycarbonate		
	Switching contact	standard:		
		silver gold-plated (Au), suitable for DDC applications: DC 24 V; 0,02 A		
	Metal bellows	1.4541 (stainless steel)		
Hood	polycarbonate			
	GW...A4/2 HP			
Hood	die cast zinc, powder coated			
Switching voltage	DDC application:	AC eff.	min. 24 V	max. 250 V
		DC	min. 24 V	max. 48 V
		DC	min. 5 V	max. 24 V
Nominal current	DDC application:	AC eff.	10 A	
		DC max.	20 mA	
Switching current	DDC application:	AC eff.	min. 20 mA	max. 6 A with $\cos \varphi$ 1
		AC eff.		max. 3 A with $\cos \varphi$ 0,6
		DC	min. 20 mA	max. 1 A
		DC	min. 5 mA	max. 20 mA
Electrical connection	Standard	at screw terminals via cable gland, M20x1.5		
	Special version	plug connection for line sockets as per DIN EN 175 301-803, 3-pin with protection contact		
Degree of protection	GW...A4 HP	IP 54 to IEC 529 (EN 60529), (clear hood)		
	GW...A4/2 HP	IP 65 to IEC 529 (EN 60529), (metal housing)		
Adjustment	With rising pressure and installed in a vertical position. Optional rising or dropping pressure adjustment on-site possible. Note switch point change if installation position changes..			
Setting tolerance	±15% switch point deviation based on the setpoint and with unit installed in a vertical position			

Dimensions [mm]

GW...A4 HP

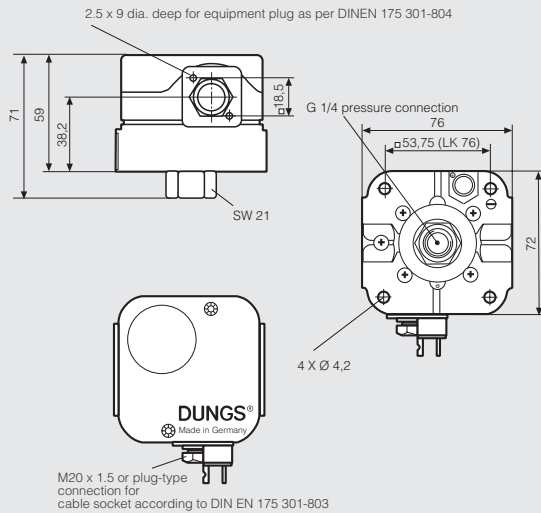

GW...A4/2 HP IP 65

with metal housing,
cable gland M 20 x 1.5

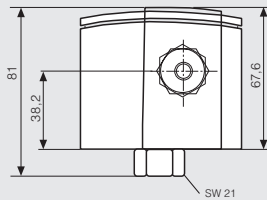

GW...A4/2 HP IP 65

with metal housing, plug-in connection for sockets
in according to DIN EN 175 301-803

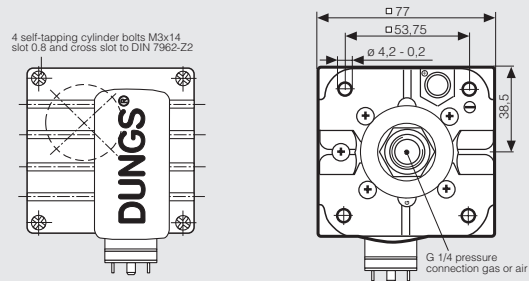
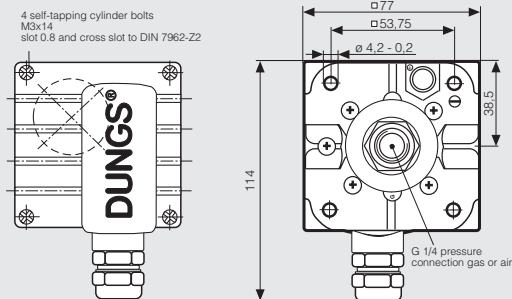
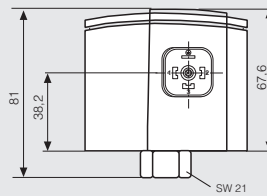

SW = Wrench width

Installation position



Standard installation position; if a different installation position is used, pay attention to the changed operating points:

GW 500 A4	HP	ca. ± 10 mbar
GW 2000 A4	HP	ca. ± 20 mbar
GW 6000 A4	HP	ca. ± 80 mbar



When installed horizontally, the pressure switch switches at a pressure higher



When installed horizontally overhead, the pressure switch switches at a pressure low



When installed at an intermediate position, the pressure switch responds if there is maximum upper or lower pressure deviation w.r.t. the set pressure reference value.

Designation

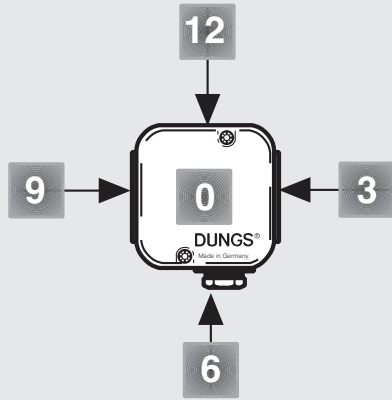

GW 500 A4 HP Au-M-V0

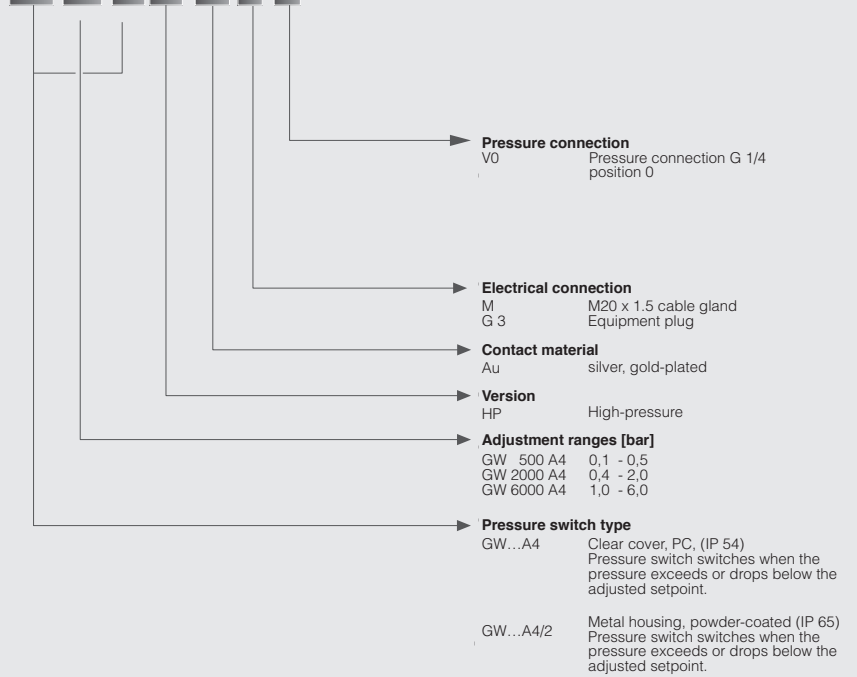

Ordering example

Pressure switch design

Pressure switch GW...A4 HP

Adjustment range

0.1 - 0.5 bar

Contact material

Au

Electrical connection

Cable gland M20 x 1.5

G 1/4 pressure connection

V0; at position 0

GW 500 A4 HP [Au-M-V0]

Accessories for pressure switches

GW...A4 HP

Bestell-Nr.

Kit: G3 equipment plug, 3-pin + E for GW...A4	219 659
Line sockets, 3-pin + E grey GDMW for GW...A4, GW...A4/2	210 318
Fluorescent lamp assembly kit 230 V yellow	231 773
Fluorescent lamp assembly kit 120 V yellow	231 772
Display LED assembly kit 24 V yellow	231 774
Fluorescent lamp assembly kit 230 V green	248 239
Display LED assembly kit 24 V green	248 240

**High-pressure switch for gas, air,
flue gases and combustion prod-
ucts**

**GW...A4 HP
GW...A4/2 HP**

DUNGS®
Combustion Controls

Technical overview 1 bar = 1000 mbar = 100 kPa ≈ 10000 mm WS

Type	Version [Au-M-V0]	Order No.	Setting range [bar]	p _{max} [bar]	Degree of protection	Differential pressure switch Δp [bar]
GW...A4 HP Pressure switch	GW 500 A4 HP	254 280	0.1 - 0.5 ↑□	2 @ 0.1 - 0.5 bar 5 @ 0.15 - 0.5 bar	IP 54	≤ 0.03
	GW 2000 A4 HP	246 665	0.4 - 2.0 ↑□	5	IP 54	≤ 0.05 @ 0.4 - 1.0 bar ≤ 0.10 @ 1.0 - 2.0 bar
	GW 6000 A4 HP	246 159	1.0 - 6.0 ↑□	8	IP 54	≤ 0.30
Supplied in separate packaging						

Type	Version [Au-G3-V0]	Order No.	Setting range [bar]	p _{max} [bar]	Degree of protection	Differential pressure switch Δp [bar]
GW...A4/2 HP Pressure switch	GW 500 A4 HP	254 285	0.1 - 0.5 ↑□	2 @ 0.1 - 0.5 bar 5 @ 0.15 - 0.5 bar	IP 54	≤ 0.03
	GW 2000 A4 HP	254 286	0.4 - 2.0 ↑□	5	IP 54	≤ 0.05 @ 0.4 - 1.0 bar ≤ 0.10 @ 1.0 - 2.0 bar
	GW 6000 A4 HP	254 287	1.0 - 6.0 ↑□	8	IP 54	≤ 0.30
Supplied in separate packaging including line socket						

Type	Version [Au-M-V0]	Order No.	Setting range [bar]	p _{max} [bar]	Degree of protection	Differential pressure switch Δp [bar]
GW...A4/2 Pressure switch	GW 500 A4/2 HP	254 281	0.1 - 0.5 ↑□	2 @ 0.1 - 0.5 bar 5 @ 0.15 - 0.5 bar	IP 65	≤ 0.03
	GW 2000 A4/2 HP	247 903	0.4 - 2.0 ↑□	5	IP 65	≤ 0.05 @ 0.4 - 1.0 bar ≤ 0.10 @ 1.0 - 2.0 bar
	GW 6000 A4/2 HP	248 678	1.0 - 6.0 ↑□	8	IP 65	≤ 0.30
Supplied in separate packaging						

Type	Version [Au-G3-V0]	Order No.	Setting range [bar]	p _{max} [bar]	Degree of protection	Differential pressure switch Δp [bar]
GW...A4/2 Pressure switch	GW 500 A4/2 HP	254 282	0.1 - 0.5 ↑□	2 @ 0.1 - 0.5 bar 5 @ 0.15 - 0.5 bar	IP 65	≤ 0.03
	GW 2000 A4/2 HP	254 283	0.4 - 2.0 ↑□	5	IP 65	≤ 0.05 @ 0.4 - 1.0 bar ≤ 0.10 @ 1.0 - 2.0 bar
	GW 6000 A4/2 HP	254 284	1.0 - 6.0 ↑□	8	IP 65	≤ 0.30
Supplied in separate packaging including line socket						

We reserve the right to make any changes in the interest of technical progress.

Head Offices and Factory
Karl Dungs GmbH & Co. KG
Siemensstraße 6-10
D-73660 Urbach, Germany
Telefon +49 (0)7181-804-0
Telefax +49 (0)7181-804-166

Postal address
Karl Dungs GmbH & Co. KG
Postfach 12 29
D-73602 Schorndorf, Germany
e-mail info@dungs.com
Internet www.dungs.com